

Fiber Management Panels

Amphenol FiberMOD Rack Mount Patch Panels provide a convenient point for patching and managing fiber optic cables. The modular and high density design of the FiberMOD panels make them ideal in data center applications, for use in the main distribution area and horizontal and equipment distribution areas. The patch panels provide easy access to the cable assemblies, suitable cable routing features, and bend radius protection for the fibers.

Features/ Benefits

- Sturdy 16 gauge steel and aluminum construction with durable black powder coat finish
- Removable doors provide increased enclosure access during installation and maintenance
- Reversible brackets allow panel to be mounted on either 19" or 23" racks
- Modular adapter packs or MPO cassettes can be pre-installed to reduce installation costs
- Variety of pre-terminated cable assemblies available pre-installed to further reduce field labor costs
- Panels provide ample room for storage of fiber slack while maintaining bend radius protection
- All enclosures include mounting hardware, installation instructions, and cable ties
- Available with Splice and Patch/Splice configurations
- Custom designs available

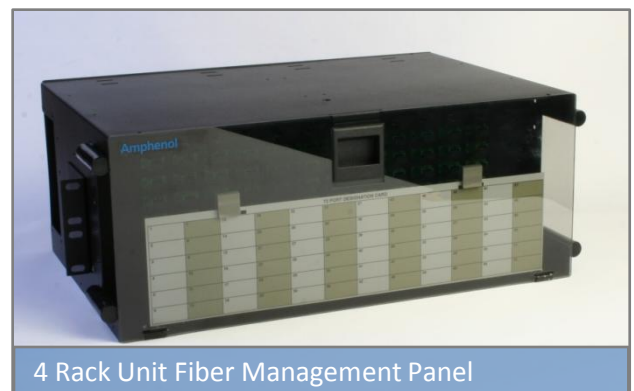
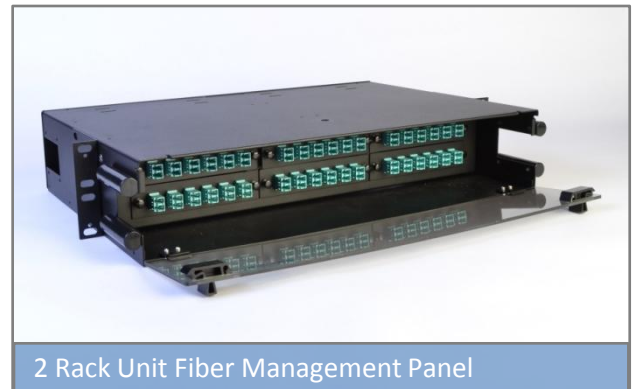
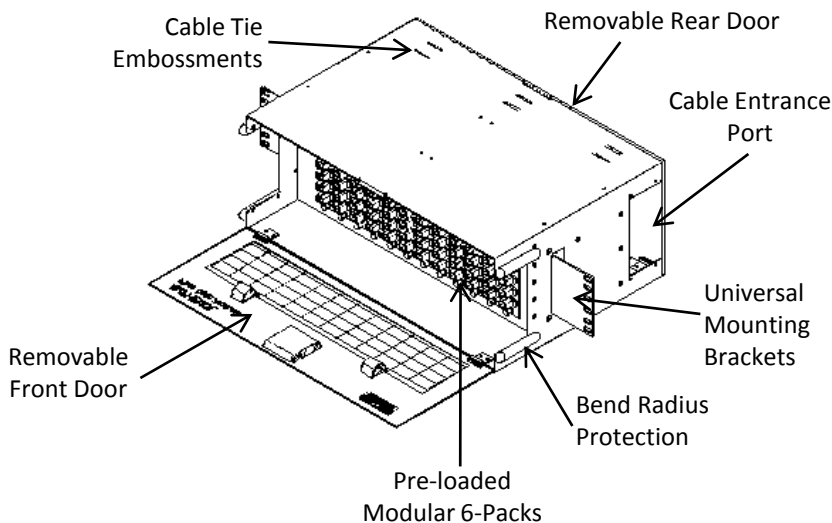

FiberMOD Fiber Management Panels

Empty Panels

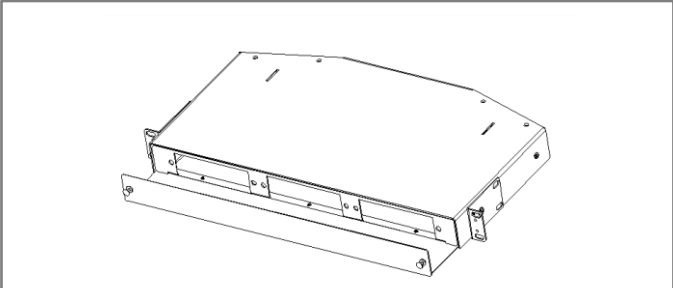

1 RU Fiber Management Panel with Sliding Drawer
(17"W x 1.7"H x 12"D)

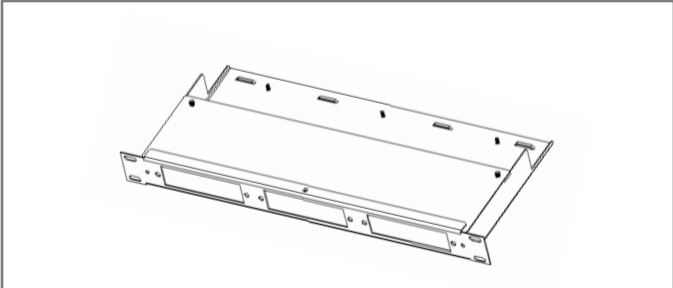

1 RU Fiber Management Panel
(17"W x 1.7"H x 8"D)

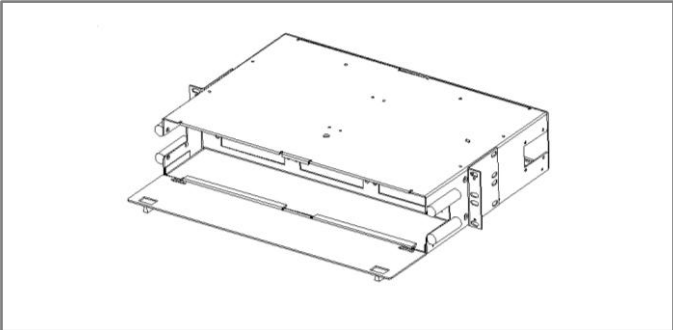

2RU Fiber Management Panel
(17"W x 3.5"H x 12"D)

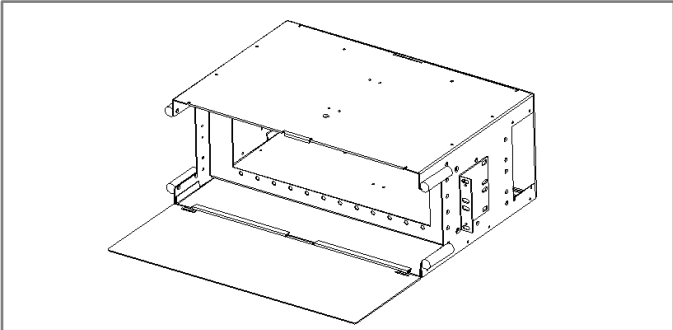

4RU Fiber Management Panel
(17"W x 7"H x 12"D)

Ordering Information:

Fiber Patch Panel*		Rack Unit	Adapter Pack or Cassette Capacity	Fiber Capacity			
Part #	Description			SC Simplex	LC Duplex	SC Duplex	LC Quad
948-99999-10208	Panel, Rack Patch, 1RU, Empty	1RU	3	18	36	36	72
948-99999-10217	Panel, Rack Patch, 1RU with sliding drawer, Empty	1RU	3	18	36	36	72
948-99999-10212	Panel, Rack Patch, 2RU, Empty	2RU	6	36	72	72	144
948-99999-10213	Panel, Rack Patch, 4RU, Empty	4RU	12	72	144	144	288

* Please contact Amphenol for other configurations.

FiberMOD Fiber Management Panels

Adaptor Packs

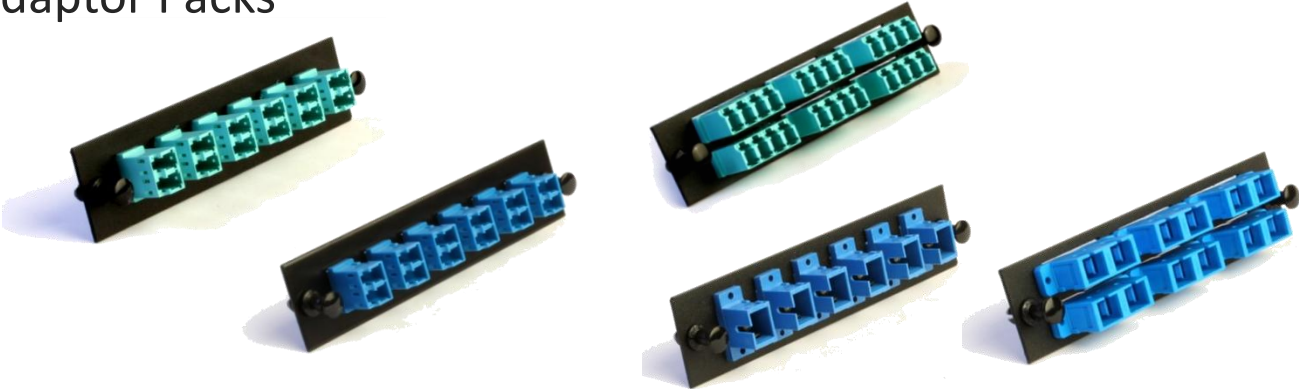

Ordering Information:

Adapter Packs for Panels*		Adapter Type	Color	Fiber Ports
Part #	Description			
948-100-2151	Adapter Pack, SC Simplex with ceramic sleeves, 6 adapters, Blue	SC	Blue	6
948-100-2154	Adapter Pack, SC Simplex with ceramic sleeves, 6 adapters, Black	SC	Black	6
948-100-2161	Adapter Pack, SC Duplex with ceramic sleeves, 6 adapters, Blue	SC	Blue	12
948-100-2164	Adapter Pack, SC Duplex with ceramic sleeves, 6 adapters, Black	SC	Black	12
948-100-2171	Adapter Pack, LC Duplex with ceramic sleeves, 6 adapters, Blue	LC	Blue	12
948-100-2173	Adapter Pack, LC Duplex with ceramic sleeves, 6 adapters, Aqua	LC	Aqua	12
948-100-2175	Adapter Pack, LC Duplex with ceramic sleeves, 6 adapters, Black	LC	Black	12
948-100-2181	Adapter Pack, LC Quad with ceramic sleeves, 6 adapters, Blue	LC	Blue	24
948-100-2183	Adapter Pack, LC Quad with ceramic sleeves, 6 adapters, Aqua	LC	Aqua	24
948-100-2185	Adapter Pack, LC Quad with ceramic sleeves, 6 adapters, Black	LC	Black	24
948-100-2191	Adapter Pack, MPO, 6 adapters, Black	MPO	Black	72
948-100-2140	Adapter Pack, Blank, No adapters	N/A	N/A	N/A

* Please contact Amphenol for other configurations.

Other Modules Available



(C/D)WDM and Splitter Modules

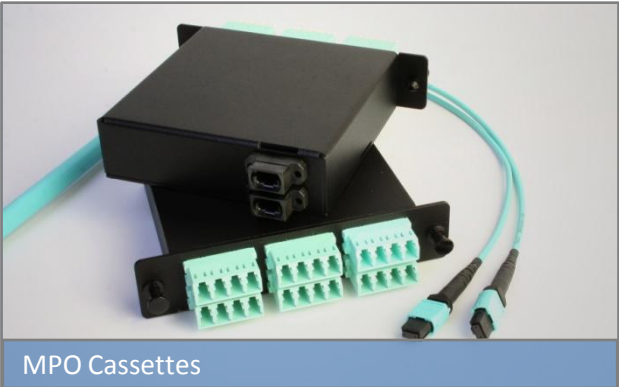

MPO Cassettes